



Digital Ignition ZDG3

**Instruction manual digital ignition ZDG3 and alternator system for
LAVERDA 1000/180° (Series I - HKZ and BTZ)**



- [1. Function](#)
- [2. Fitting](#)
- [3. Electrical connection](#)
- [4. Adjustments](#)
- [5. General](#)

Instruction manual digital ignition ZDG3 and charging system for
Laverda 1000-180° (Series I - Bosch BTZ and HKZ)

1. Function - [2. Fitting](#) - [3. Electrical connection](#) - [4. Adjustment](#) - [5. General](#)

The digital ignition ZDG3 and the alternator system replaces all parts of the old ignition and charging system. With 320W a powerful charging is guaranteed.

Function: per revolution of the crankshaft starting from TDC, the momentary peripheral speed is determined and by this means, the time up to ignition is calculated. Because the peripheral speed varies substantially during acceleration, this long measurement is selected in order to determine a relatively exact measurement.

The following computation of ignition timing is divided into 4 ranges:

1.	0-400 rpm	Starting range, ignition always at TDC
2.	400-1000 rpm	Idling range, 2° to 8 ° advanced ignition, depending on curve selection
3.	1000-6200 rpm	Partial load range, the spark advance adjustment occurs here
4.	6200-10000 rpm	maximum load range, constant 32° - 39° advanced ignition, depending on curve selection



ignition box, alternator system and regulator

The measurement occurs by magnetic sensitive electronic devices (Hall effect sensors) which have a high temperature compatibility.

If the engine stops, the ignition current will be switched off after 3 sec. to protect the ignition coils.

9 ignition curves are available

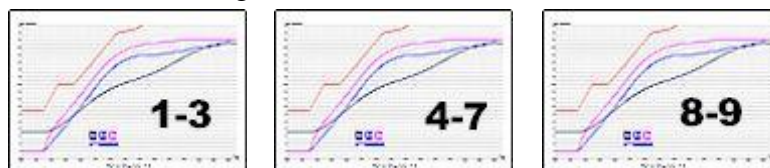

click to e

Instruction manual digital ignition ZDG3 and charging system for
Laverda 1000-180° (Series I - Bosch BTZ and HKZ)

[1. Function](#) - [2. Fitting](#) - [3. Electrical connection](#) - [4. Adjustment](#) - [5. General](#)

First step, remove Alternator Cover and peen back Lock Tab that is installed behind the Alternator nut. Remember that this nut is a **LEFT HAND THREAD**. Remove Nut as required. We use a Rattle gun but it can also be removed using a suitable Socket and Breaker Bar.

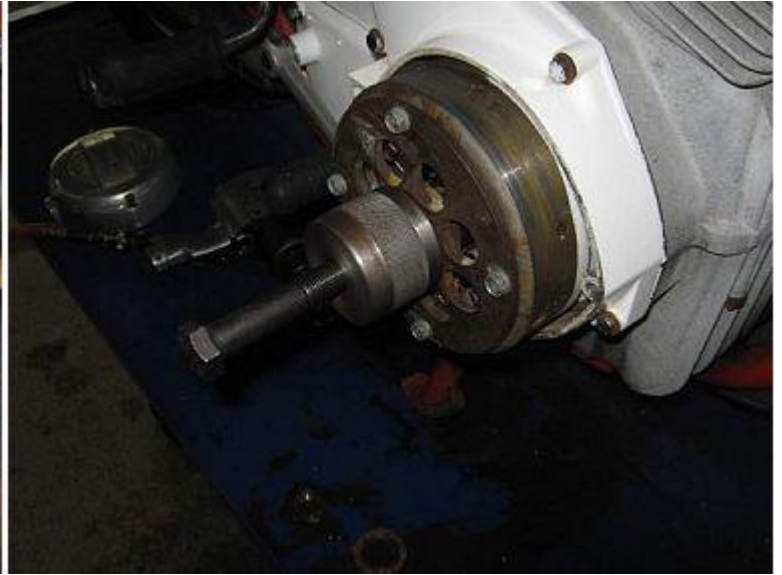

You will have something looking like the photo above.

To remove the Alternator it is best to use a factory Puller or a suitable Puller machined similar to the Factory Puller, external thread is 45.0 x 1.5mm . See photo on right hand side above. We understand that not everyone has access to this form of puller but in reality, it is the only one that works without doing damage to the workings.

Once Alternator Rotor is removed, unbolt the Alternator Stator/Ignition plate by undoing the two Screws and remove from the Crankshaft. At this stage also remove the Ignition Rotor by undoing the small Allen headed Grub Screw but remember to remove the Woodruff Key from the end of the Crankshaft first.

You should now have the Stator hanging down on its wires. Trace the wiring back to its termination point and unscrew the ends. You can now pull the wiring through the wiring access tunnel in the Alternator Cover.

Prior to removing the wiring you may wish to also remove the Air Filter Box, Starter Motor and the Engine Breather Hose to make life simpler later in the installation process .

At this stage you should have a bare mounting area as on the right photo. If your Crankshaft Oil Seal is leaking it is advisable to change it at this point. This can be identified by oil stains or oil wet patches inside the above cover. The seal is a TC 12519 or by dimensions, 35 x 47 x 7 Oil Seal. This seal can be accessed by undoing the inner Nut that can be seen above and this thread is also a **LEFT HAND THREAD**. One needs to use an extended Socket to remove this nut and is not a tool that most people will have at hand. To remove the seal, use either a Seal Pick or drill a very small hole, approx 2 - 3mm in the outer rim of the seal and then screw in a self tapping screw which will force the seal to pop out or you can use a pair of Pliers to pull the seal out by grabbing hold of the self tapping screw.

Alternative method is to just remove the Inner Alternator cover while you are there and especially as you have already removed the wiring going through the cover.

May as well just for a look and can clean out and inspect the Starter Clutch while you are in there.

Installation of the seal is quite simple, use a soft punch and gently tap the seal back into position. Note where outer edge of the seal is in relation to the inner cover prior to removing original seal. Reinstall Left Hand Nut and tighten. We always use thread sealant on the inner thread of this Left Hand Seal nut, this makes certain no oil can work its way through the thread form. Don't use Threadlock on this nut.

Before proceeding further dummy fit the new Ignition Rotor onto the Crankshaft to make certain that it can slide over the shaft freely. It is necessary to make certain that the Rotor is free to move along the shaft and rotate when in position as this is how the ignition timing will be set later in the installation process .



These cranks have been around for years and it is not uncommon to find small dings and bruises on the crank outer shaft that will need careful dressing with a fine file or Wet and Dry sandpaper . Do this now to avoid issues later. Once it is confirmed Rotor installs freely along all of the shaft remove Rotor.

Next, install Backing Plate and Ignition module as provided in your kit using supplied Allen Headed Bolts and Washers. Cable relief slot goes down as shown in photo below.

Set the base plate so cable relief groove lines up with original cable relief cast into the Inner Alternator cover. This is important as the cables need to be tucked in through this slot so they stay clear of the spinning rotor when the engine is running.



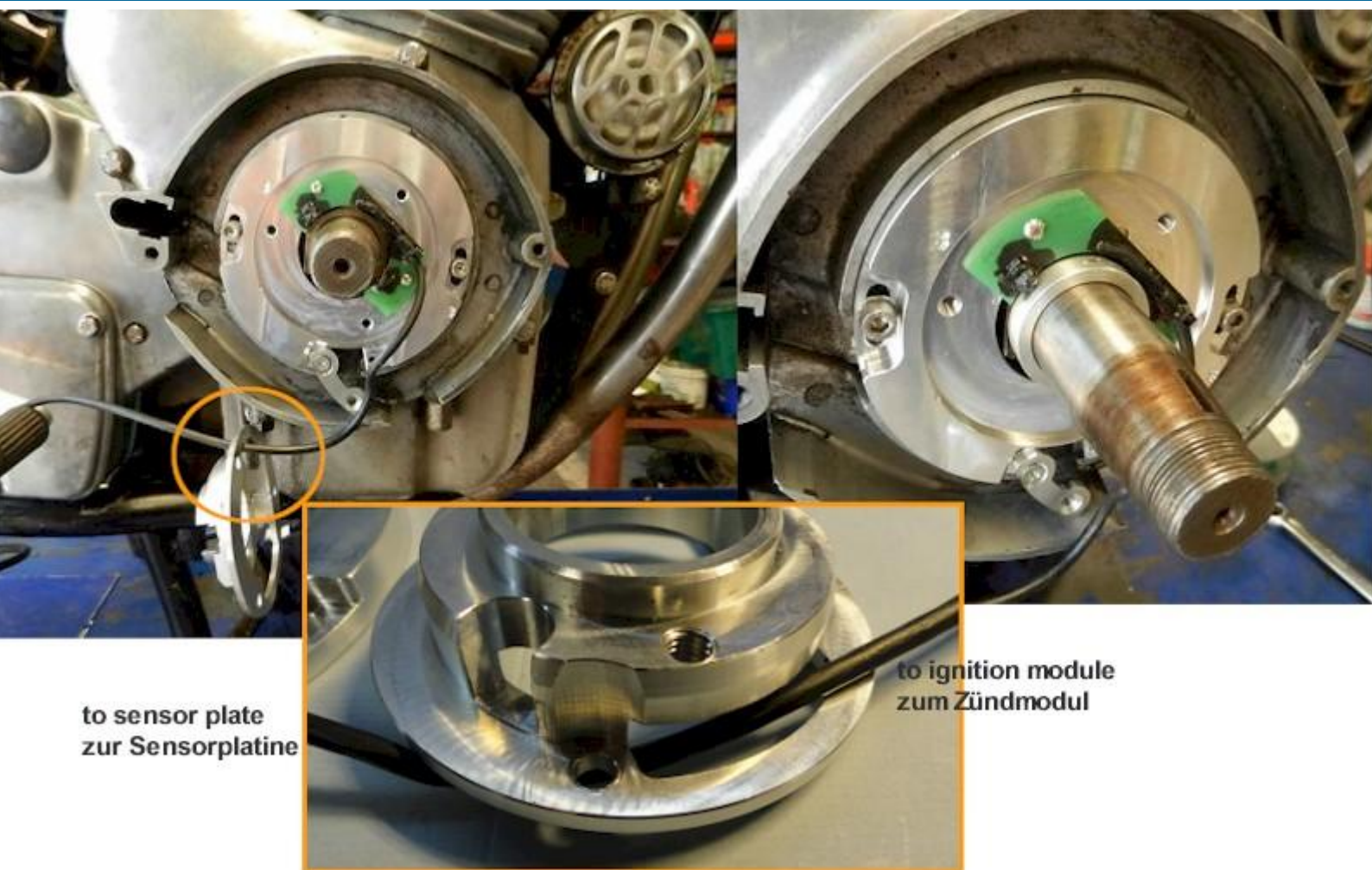

to sensor plate
zur Sensorplatte

to ignition module
zum Zündmodul

Next step is to slide the Rotor over the shaft into a position just proud of the Base Plate. Rotor goes onto the crankshaft with the letters "N" (North) and "S" (South) visible, as in, facing out.

Laverda 1000-180° (Series I - Bosch BTZ and HKZ)

[1. Function](#) - [2. Fitting](#) - 3. Electrical Connections - [4. Adjustments](#) - [5. General](#)

HKZ systems need to change out the original Coil packs mounted at the steering head for a set of TEK MP- 08 dual coil and TEK KP - 03 single coil units. Other coils are able to be used, 3 ohm rated coils are recommended.



Remove Coil packs as shown above.



Also remove the original CDI Rectifier on the HKZ systems that is mounted near the Battery tray area of the bike.

There is one wire we need from the Rectifier and that should be the Red wire if wiring is standard. It is easy to identify as it is the wire that goes back to the Battery though sometimes it feeds through the Fuse Box first. (See the wiring diagram down on the page)

It is now time to install the supplied 3 phase Regulator. It is up to the owner where you wish to install the Regulator but we recommend on the early CDI equipped bikes that it is installed on the Rear Mudguard below the Tool Tray as shown by drilling 2 x 6.5mm holes.



Pack a rubber strip or rubber washers between the guard and the Regulator so it does not conform to the radiused shape of the guard when you tighten the nuts, use Nyloc nuts as shown.

For owners with the BTZ ignitions, just remove your current Regulator and install the 3 phase unit in the same position, mounting holes and Regulator size are the same.

Next we have to thread the new cables through the Alternator cover tunnel and this is where it is

advisable to have the Starter Motor removed. It is recommended that both Cables, being the Black sheathed Ignition cable and the Blacksheathed Stator Cable are taped together at the ends but do not use excessive tape as there is a minimum amount of room in the tunnel area.

If you have problems pulling the two cables through the tunnel you can also tape a single wire onto the cables and gently pull them through.

Once through you can remount the Starter Motor but do not mount the Alternator Stator or Adaptor Plate at this stage. Just leave both hang down from the cover.

Run both cables to their approx position. Alternator wiring which are the 3 x yellow wires go to the plug installed on the cable coming from the Regulator. It does not matter which yellow goes where, as long as plug is connected with all the yellows in line. As in, 3 x yellows to 3 x yellows.

There are 3 other wires coming from the Regulator, Green lead is Earth and can be installed on a frame Earth or direct back to Battery.

White/Red wire is the main charge lead and goes to Positive side of Battery.

Last wire is the Red wire and is run to a live 12 volt wire.

This Red wire is the sensing circuit and must be connected to a live circuit or direct to the positive side of the Battery. Its purpose is to tell the Regulator when to restrict the charge being sent to the Battery through the Red/White wire. If the sensing circuit is not connected the Battery will see unregulated power feed of anything up to 19 volts and it will damage your Battery, blow Headlight bulbs, etc. With the sensing circuit connected you should record approx 14.7 volts at the Battery with the bike running.

Now to the ignition wiring. You will note that the wiring code is written on the front of the ignition module and is quite easy to follow.

Connection allocation of the system plug

1	twin ignition coil (left and right cylinder)
2	ground (ensure good contact to the frame!)
3	brown, ground (Pickup)
4	green (Pickup)

5	yellow (Pickup)
6	white, +5V (Pickup)
7	output for an electronic rev. counter (if used)
8	+12V (12V supply voltage from the ignition switch)
9	ground
10	ignition coil center cylinder

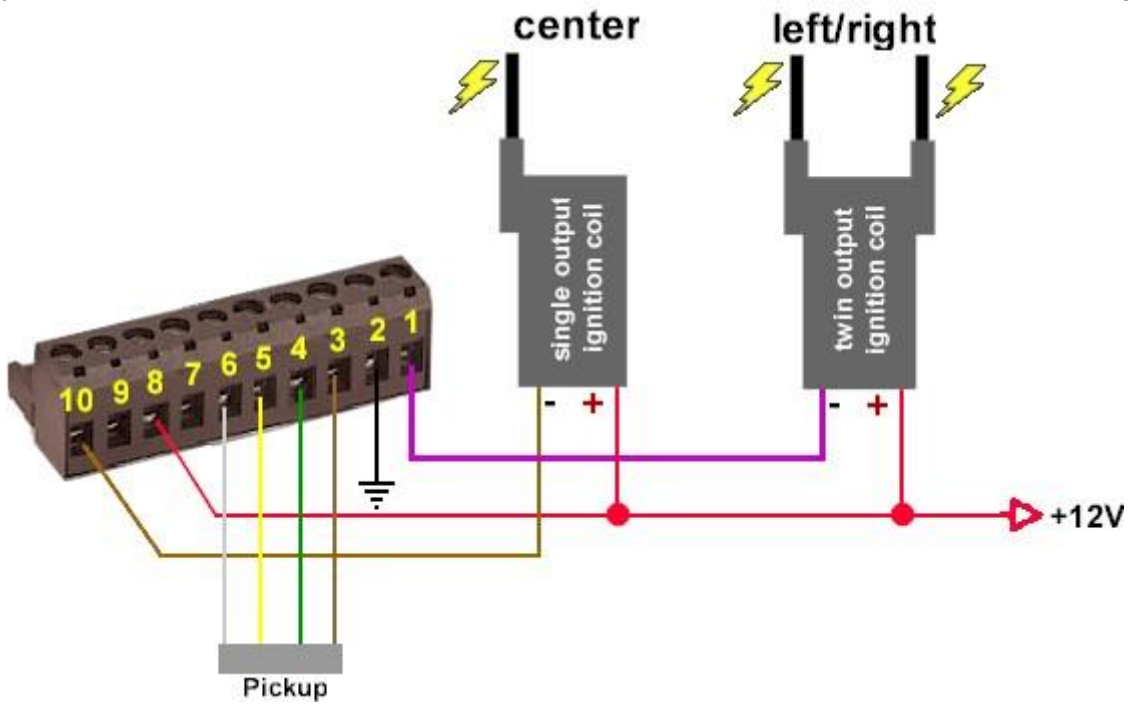

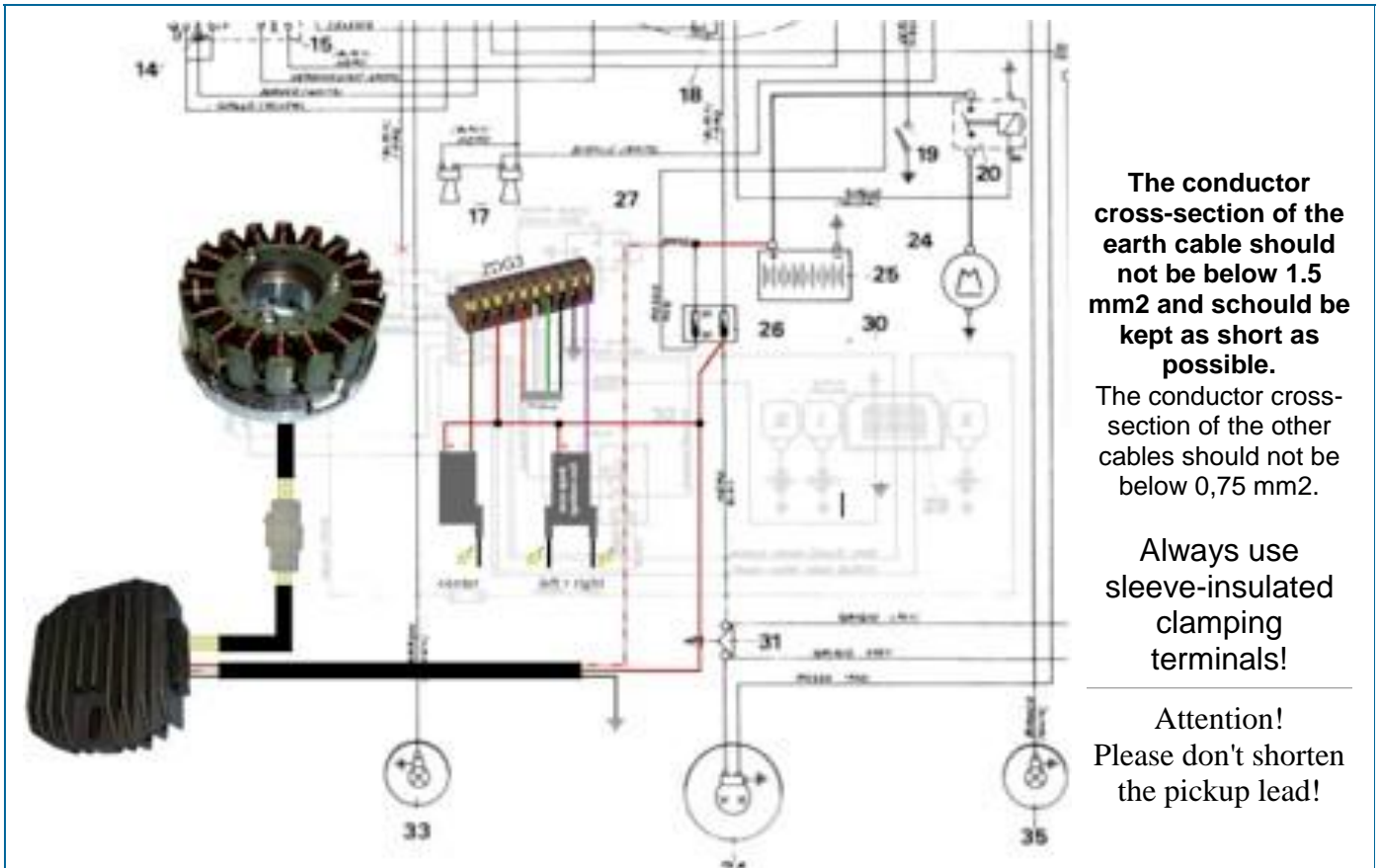

The conductor cross-section of the earth cable should not be below 1.5 mm² and should be kept as short as possible.

The conductor cross-section of the other cables should not be below 0,75 mm².

Always use sleeve-insulated clamping terminals!

Attention!
Please don't shorten the pickup lead!

click to resize

Note: When wiring in the Coils make certain that you remove the Ballast Resistors if they are still installed, it is not recommended to use these items when using an Electronic Ignition.

To test the ignition circuit we recommend that three old Spark Plugs are used with the electrodes cut away flush with the face. By increasing the Electrode gap it has the effect of increasing the load on the Coils, Ignition Leads, Ignition circuit etc and in effect load tests the whole circuit.

Lay the Spark Plugs onto the head where they have a good contact and turn on the Ignition with the Control box rotary switch selected to Zero (0), this activates the test mode and supplies a continuous spark to all three Spark Plugs.

Instruction manual digital ignition ZDG3 and charging system for Laverda 1000-180° (Series I - Bosch BTZ and HKZ)

[1. Function](#) - [2. Fitting](#) - [3. Electrical connections](#) - 4. Adjustments - [5. General](#)

To set the Ignition timing we need to position the engine to Top Dead Center on No 1 cylinder or the left hand Cylinder. We recommend using a Piston stop and degree wheel to obtain TDC or a Dial Indicator but few people will have this equipment at hand. Alternative is to use a screwdriver and lots of patience.

Remove all the Spark Plugs from the Cylinder Head and by using a thin screwdriver, insert the screwdriver down the left or right hand cylinder Spark Plug hole until it rests on the Piston. Now slowly rotate the engine to find Top Dead Centre by carefully watching or feeling the screwdriver lift up with the Piston. You are trying to find TDC within +/- 0.2mm so be patient as it may take a number of attempts to finally be satisfied that you are in the correct position.

While doing this you will note that the Piston will dwell at TDC, it is best to try and identify the area where the piston stops moving up and before it starts to move back down, you are trying to get the piston stopped at the midpoint of this dwell.

Note that it does not matter which stroke the piston is on as the ignition system operates on the Wasted Spark principal. This means that every time the Piston reaches TDC the Ignition system fires, even if it is on the Exhaust stroke. This method of ignition is the most common used on engines with crankshaft mounted ignition systems except for modern engines with Engine management systems which have the ability to use sequential firing ignitions.

Once you are satisfied that the engine is at TDC and all of the wiring loom is completed it is now possible to turn on the ignition switch and position the Rotor disc.

There is only a small clearance between the Rotor and the Triggers so screw the 3 x Grub Screws in so they touch the crank and then back them out by ¼ turn so Rotor spins freely. Make certain that the Spark plug caps have Spark Plugs installed and are earthed out to the motor. Set the Rotary Selector Switch on the Ignition black box to Four (4), turn on the ignition, position the Rotor so the magnets line up with the Triggers and slowly turn Rotor clockwise, you need to have "S" go past the rear mounted Trigger and continue rotating the Rotor slowly so "N" approaches the rear Trigger which is the Trigger for Cylinders 1 and 3. As soon as the red LED light goes out that is the position where you need to lock the Rotor in place.



This marks the TDC position and is what the system needs to calculate where it is in regards to crankshaft angle. Tighten one of the Grub Screws on the Rotor but not before checking to confirm that the Rotor disc is evenly spaced within the Sensor itself. See diagram below. Note: you can't switch the LED on only by turning back to the 'N'-position. If you need to make a couple of goes at this setting then the Rotor must be turned back past to the 'S' marked position to reset the system.

I suggest that when you tighten the 4mm Grub Screws that you tighten one first and then when installing 2nd and 3rd Grub Screws, apply a small amount of Loctite to them, tighten them in position then remove the first Grub Screw and apply Loctite to it as well. You will need to turn the crank to line up the Grub Screws to an area on the Ignition board where they will clear the electronics to allow the Loctite to be applied.

- With the engine at TDC as described above, turn on the Ignition switch
- Turn the 'S'-marked Magnet clockwise close to the rearward sensor. Take care that the magnets in the Rotor disk are approximately at the same height and position as the sensor.

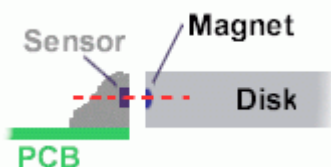

- Go on turning the Rotor disk. The LED light on the rear sensor should light up at the 'S' -

marking.

(It is possible that the LEDs already indicating at power on)

- Turn the disk slowly to the 'N' - marking until the LED is switching off. The Rotor disk is in the correct position and can be tightened by the Grub screws.

Note: It is possible to start the engine at this stage to confirm that everything is installed correctly.

We

recommend position 4 or 5 on the ignition curve selector switch as being the better of the curves to suit

your Laverda engine.

Once engine is started and runs fine and Ignition system is shown to be correct you can proceed with

installing the Alternator system.



Install the Stator Adaptor as shown left . Stator is installed next and it only fits in one position . Install the cables behind the supplied cable bridge clamp at this stage but do not tighten the screws until Stator is roughly positioned. You need to position the Stator over the crankshaft and have it loosely in position, make certain cables are free to move in the cutout area and are not being pinched, tighten the Allen head screws in the Cable clamp and then bolt the Stator to the Adaptor.



We recommend you use one of the Loctite Threadlock products on these Stator bolts and do not overtighten the bolts or you will strip out the tapped threads in the Adaptor Plate. Only use the supplied Button Head Bolts and Spring Washers when installing the Stator, DO NOT ADD ANY MORE WASHERS TO THE BOLTS, clearance between the Bolt heads and the inside of the Rotor is tight when installed.

Once the Stator is installed slide the Alternator Rotor onto the Crankshaft end and line the keyway slot up with the Woodruff Key in the Keyway slot.

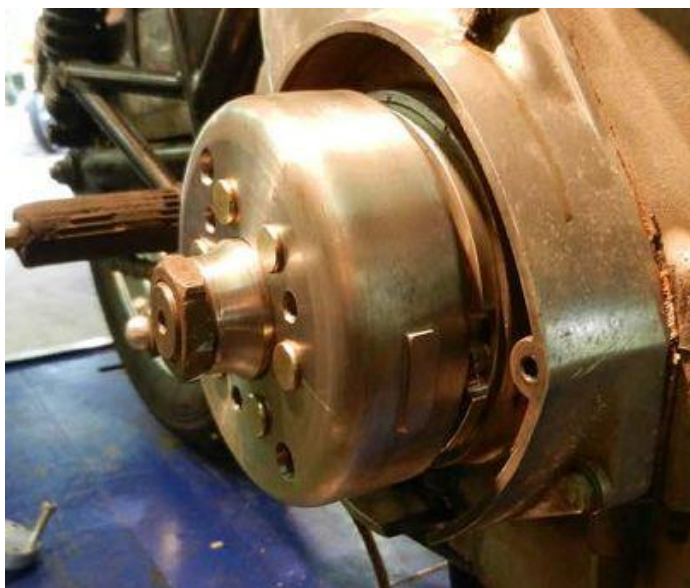

Installation should now be looking like the photo left.

Make certain that the cables are out of the way of the spinning Rotor, they will quickly wear through if they are able to touch the Rotor when the engine is operating.

This Rotor has been configured so the timing marks on the Rotor line up with the original Laverda marks and as such, can be used to check the timing of the Ignition with a Strobe Light. There is a bit of a gap now between the Rotor markings and the mark on the Alternator cover due to the reduced diameter of the Rotor but we have found it is still possible to check for total advance and idle advance with not too many problems.

Fire the bike up again and check the marks using the Strobe light as per normal Laverda instructions.

It is also a good idea to check the Voltage at the Battery while the bike is running to confirm that the

Charging circuit and replacement Regulator have been installed correctly. Increase the RPM through to approx 4,000 RPM at which stage you should be able to measure the Voltage at the Battery Positive post.

Should be in the region of 14.7 volts if all is working correctly.

Reassemble the rest of the bike as required and get ready to go for a ride.

The Rev Limit DIP switch No 1 can be found at the front of the ignition box , shown here in the down position :



DIP Switch 2 should be in the "up" position for Crankshaft counter frequency selection.

Curve selection switch shown at the right hand side, is currently in Curve 2 selection.

switch adjustment			
rotary switch (curve selection)		DIP switch	
1-9	curves 1-9	1	overspeed protection at 7900 rpm (switch down) or at 9800 rpm (switch up)
0	test mode, continuous firing	2	rev. counter frequency (switch up >> Outputfreq. =crankshaft switch down >> Outputfreq.=camshaft)

[1. Function](#) - [2.Fitting](#) - [3. Electrical connection](#) - [4. Adjustment](#) - 5. General

Only use interference-free spark plug caps!
(recommended NGK caps with 5kOhm internal resistance)

Malfunction sources :

Doesn't start :

If the engine should not start, or the starting procedure is suddenly strangled, then the ignition coils are mixed up. If so, swap the ignition cables which lead to the spark plugs or reconnect the ignition coils. You can check the function of the ignition by unscrewing the spark plugs, leaving them in the plugs and connect to ground. Now start the engine with an attached timing lamp and check the ignition timing. Because of the missing spark plugs the engine runs fast enough to see a stable ignition at TDC. To check the cable connecting and the supply voltage put the rotary switch to '0'. Now the spark plugs will fire continually.

If the engine does not start while cranking on the starter motor and the engine is turning over slowly, most likely cause is the Battery is low in power and the battery voltage falls under the minimum supply voltage of the ignition (approx. 7V).

Sporadic engine cutout :

If sometimes the engine suspends for 2-3 seconds while driving and keeps running thereafter normally that means that the ignition has been reset. The causes of this malfunction could be a broken spark plug connector or a loose ignition cable.

But in most cases a bad connection to the operating voltage supply causes this effect (starter lock, fuse holder etc.). For testing you can connect a wire directly from the ignition box power supply to the positive terminal of the battery. If the ignition now runs perfect, you've got an malfunction in the wiring harness. With points such a malfunction is not noticeable, because a short break of the power supply doesn't matter. In contrast electronics are very sensitive to weak power supplies.

Volker Sachse
Motorcycle Electronics

Lerchenweg 12
32312 Luebbecke
Germany
Tel. 0049 5741/61188
Mobil: 0049 160/9414 2224
info@elektronik-sachse.de
www.elektronik-sachse.de